

AZ/EL Positioners - Heavy Duty

AL-4316-1 • AL-4306-1 • AL-4307-1 • AL-4317-1 • AL-4309-1 • AL-4310-1

The MVG-Orbit/FR Legacy Series AZ/EL Positioners provide accurate, balanced rotation, and controllable velocity. Their rugged yet straight-forward construction ensures maximum reliability and trouble-free operation, yielding the best size and weight/performance ratio.

Typically, the unit includes the body, precise slew bearings, DC motor, gear reducer, encoder/synchro, and limit switch assembly. The turntable surface is designed with a threaded mounting hole pattern for ease of use. A Safe/Operate switch is included to ensure safety.

AL-4317-1

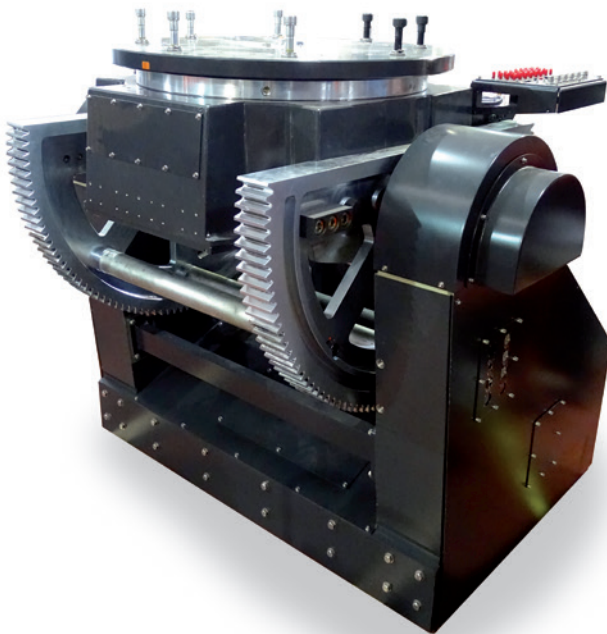





Applications

- General Purpose Positioning Subsystems
- Far-Field & Near-Field Antenna Measurements
- Indoor & Outdoor Use

Product Highlights

- Vertical Loads Ranging from 30,000 to 45,000 lbs (13,610 to 20,410 kg)
- Turntable Diameters Ranging from 34.3 to 74.0 in (870 to 1,880 mm)
- Excellent Angular Position Accuracy
- Low Backlash Design
- Precision Bearings
- Closed Loop Servo Control
- Industry-Standard Wiring
- Tachometers for Optimum Speed Regulation & Control
- Wide Operating Temperature Range: -4° F to 140° F (-20° C to 60° C)
- Fully Enclosed Design of Drive Gear Train & Data Take-Off
- Wide Variety of Available Options

Specifications - Legacy Series AZ/EL Heavy Duty Positioners

PARAMETER	UNITS						
							
		AL-4316-1	AL-4306-1	AL-4307-1	AL-4317-1	AL-4309-1	AL-4310-1
Dimensional Drawing Number	DCD	10-2099	10-1928	10-2100	216-0545	10-1929	10-1930

OPERATIONAL

Bending Moment	ft-lbs	30,000	35,000	45,000	55,700	150,000	300,000	
	kg-m	4,150	4,840	6,220	7,700	20,740	41,480	
Vertical Load	lbs	30,000	30,000	30,000	33,000	40,000	45,000	
	kg	13,610	13,610	13,610	15,000	18,140	20,410	
Delivered Torque	Azimuth	ft-lbs	2,800	3,000	5,000	10,000	30,000	30,000
		kg-m	390	415	690	1,380	4,150	4,150
	Elevation	ft-lbs	20,000	24,000	30,000	52,000	100,000	260,000
		kg-m	2,765	3,320	4,150	7,200	13,830	35,950
Withstand Torque	Azimuth	ft-lbs	4,200	4,200	7,000	12,000	35,000	45,000
		kg-m	580	580	970	1,660	4,840	6,220
	Elevation	ft-lbs	30,000	35,000	45,000	60,000	150,000	300,000
		kg-m	4,150	4,840	6,220	8,370	20,740	41,480
Drive Power	Azimuth	hp	3/4	3/4	3/4	1.5	5	5
	Elevation	hp	3/4	3/4	3/4	1.5	5	5
Nominal Speed	Azimuth	rpm	0.5	0.5	0.2	0.2	0.33	0.15
	Elevation	deg/min	20	20	15	7	25	8
Standard Angle Transducer Format		Absolute Encoder	Absolute Encoder	Absolute Encoder	Absolute Encoder	Absolute Encoder	Absolute Encoder	
Standard Accuracy	Azimuth	deg	± 0.03	± 0.03	± 0.03	± 0.03	± 0.02	± 0.02
	Elevation	deg	± 0.04	± 0.04	± 0.04	± 0.04	± 0.03	± 0.03
Maximum Backlash	Azimuth	deg	0.04	0.04	0.04	0.04	0.03	0.03
	Elevation	deg	0.03	0.03	0.03	0.03	0.03	0.03
Elevation Limit-to-Limit Travel	deg	+ 92 to - 45	+ 92 to - 45	+ 92 to - 45	+ 92 to - 45	+ 92 to - 35	+ 92 to - 45	

PHYSICAL

Height at 0° Elevation	in	39.0	53.3	53.3	65.1	74.8	103.5
	mm	990	1,354	1,354	1654	1,900	2,630
Weight	lbs	2,300	4,300	5,800	4840	15,000	35,000
	kg	1,043	1,950	1,750	2200	6,804	15,876
Turntable Diameter	in	34.3	34.3	34.3	34.3	44.6	74.0
	mm	870	870	870	870	1,134	1,880

ENVIRONMENTAL

Operating Temperature	- 4° F to 140° F (- 20° C to 60° C)
-----------------------	-------------------------------------

PARAMETER	UNITS							
-----------	-------	--	--	--	--	--	--	--



AL-4316-1



AL-4306-1



AL-4307-1



AL-4317-1



AL-4309-1



AL-4310-1

OPTIONS

EN001	Incremental Encoder (Standard Accuracy)		Opt	Opt	Opt	Opt	Opt	Opt
	Accuracy – Azimuth	deg	± 0.03	± 0.03	± 0.03	± 0.03	± 0.02	± 0.02
	Accuracy – Elevation	deg	± 0.04	± 0.04	± 0.04	± 0.04	± 0.03	± 0.03
EN002	Direct Incremental Encoder (High Accuracy)		Opt	Opt	Opt	Opt	Opt	Opt
	Accuracy – Azimuth	deg	± 0.005	± 0.005	± 0.005	± 0.005	± 0.005	± 0.005
	Accuracy – Elevation	deg	± 0.005	± 0.005	± 0.005	± 0.005	± 0.005	± 0.005
EN003	Direct Absolute Encoder (High Accuracy)		Opt	Opt	Opt	Opt	Opt	Opt
	Accuracy – Azimuth	deg	± 0.005	± 0.005	± 0.005	± 0.005	± 0.005	± 0.005
	Accuracy – Elevation	deg	± 0.005	± 0.005	± 0.005	± 0.005	± 0.005	± 0.005
SR	Slip Ring ³		SR051U	SR051U	SR051U	SR051U	SR051U	SR051U
			SR101U	SR101U	SR101U	SR101U	SR101U	SR101U
			SR201U	SR201U	SR201U	SR201U	SR201U	SR201U
			SR301U	SR301U	SR301U	SR301U	SR301U	SR301U
			SR402U	SR402U	SR402U	SR402U	SR402U	SR402U
			SR502U	SR502U	SR502U	SR502U	SR502U	SR502U
			SR502U	SR502U	SR502U	SR502U	SR502U	SR502U
RJ	Rotary Joint ³		RJ12U	RJ12U	RJ12U	RJ12U	RJ12U	RJ12U
			RJ18U	RJ18U	RJ18U	RJ18U	RJ18U	RJ18U
			RJ26U	RJ26U	RJ26U	RJ26U	RJ26U	RJ26U
			RJ40U	RJ40U	RJ40U	RJ40U	RJ40U	RJ40U
			RJ50U	RJ50U	RJ50U	RJ50U	RJ50U	RJ50U
			RJ50U	RJ50U	RJ50U	RJ50U	RJ50U	RJ50U
TH	Central Thru-Hole Inner Diameter		TH002-HD-U	TH002-HD-U	TH002-HD-U	TH002-HD-U	TH002-HD-U	TH002-HD-U
		in	6.5	6.5	6.5	6.5	8.0	8.0
		mm	165	165	165	165	203	203
EX	Internal Harnessing		EX002	EX002	EX002	EX002	EX002	EX002
CF	Connector Format		–	–	–	–	–	–
LS	Leveling Screw (set)		LS002-4	LS002-4	LS002-4	LS002-4	–	–
ST	Stow Lock		ST002U	ST002U	ST002U	ST002U	ST002U	ST002U
			ST002E	ST002E	ST002E	ST002E	ST002E	ST002E
MM	Mounting Thread		MM002	MM002	MM002	MM002	MM002	MM002
IC	Interlock Circuit		IC002	IC002	IC002	IC002	IC002	IC002

(-) N/A Opt Optional Deg degree

Supplied Accessories

Digital Documentation Set

User Manual (Installation, Setup, Operation & Maintenance)

Technical Notes

- 1** All accuracy data is based on no-load conditions
Contact MVG-ORBIT/FR for accuracy under load conditions
- 2** All models are equipped with adjustable limit switches capable of approx 20° to 900° total travel in AZ axis and limited travel in EL per specs. When rotary joint and slip ring options are specified, limit switches remain but are electrically disabled
Multi-axis positioners are factory-set at:
- Azimuth Axis: 400° (± 200°)
 - Elevation Axis: 137° (- 45° to + 92°)
 - Models 4316 thru 4310
 - Model AL-4309 = - 35° + 92°
- 3** Slip Ring & Rotary Joint Option Notes:
- Certain slip ring options may require an extension cap that protrudes above the turntable surface. Positioner height may increase. Consult MVG-ORBIT/FR
 - Slip ring contacts are provided with dedicated connectors
 - When rotary joint and/or slip ring options are specified, no central thru-hole is available to the user. Option TH002-U are available in lieu of rotary joint and/or slip ring options
 - Hole path is through azimuth only
- 4** All models are delivered standard with Absolute Encoder

AL-4309-1

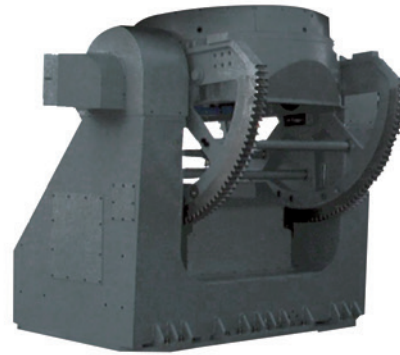

Dimensional drawing - AL-4317-1*

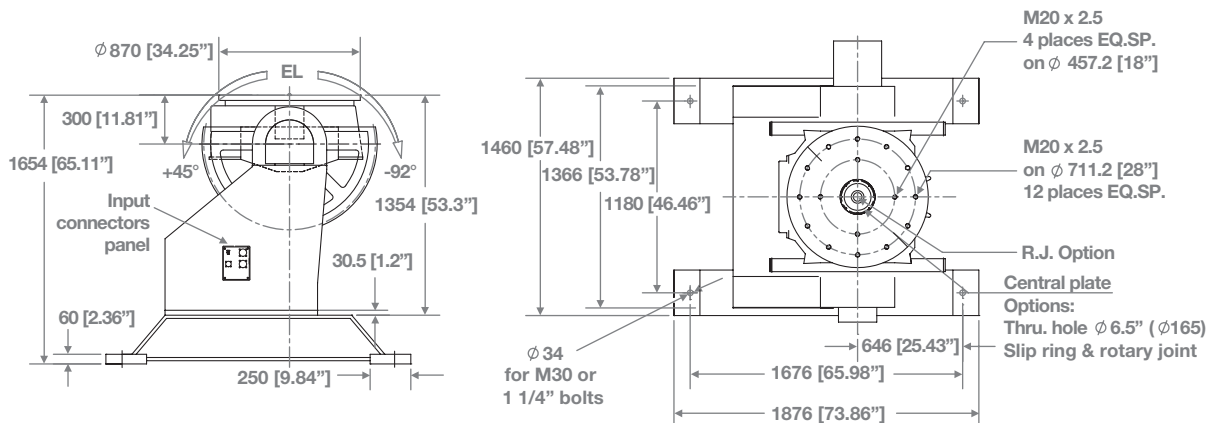

* Example drawing for general reference, please consult MVG-Orbit/FR for ICD.



Contact your local sales representative for more information
salesteam@mvg-world.com
www.mvg-world.com/positioners